

NB-6 Condensate PH Treatment Tank

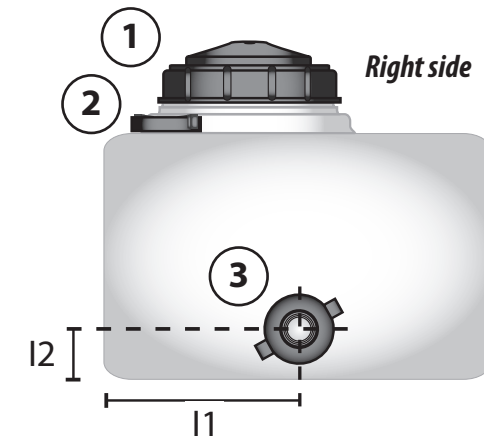

JJM Boiler Works, Inc.
Ph Neutralizing Tubes & Tanks

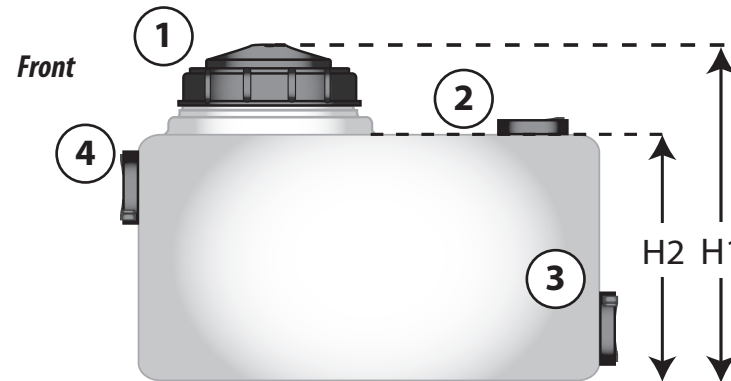
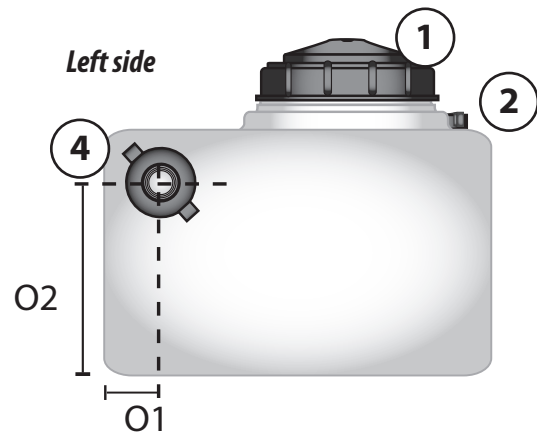
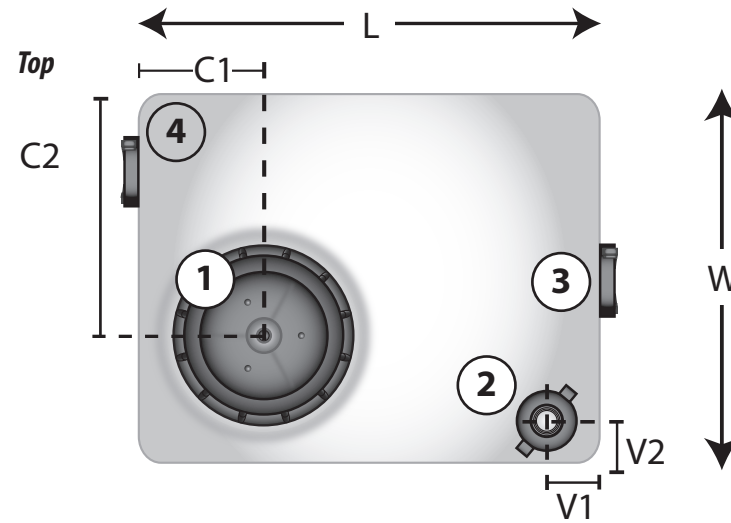

Ratings & Dimensions (in inches)																		
Model	MBH	GPH	L	W	H1	H2	①	C1	C2	②	V1	V2	③	I1	I2	④	O1	O2
NB-6	6000	45	16	12	11 1/4	8	Cap 4 1/2" port	4 7/8	7 7/8	Vent 3/4" port	1 3/4	1 3/4	Inlet 1" port	6	1 3/4	Outlet 1" port	2 1/4	5 3/4